

SPEC DRAWING IQ3600HEV
 COOLING CAPACITY: 29.4 WATTS/°F
 DIMENSIONS: 32"H X 16"W X 6"D
 WEIGHT: 43 LBS.

MAXIMUM AMPS: 5.4/6.0 @ 120/110 VAC 60/50HZ
 MAXIMUM AMPS: 2.7/3.0 @ 230/220 VAC 60/50HZ

IQ3600HEV
TOP VIEW

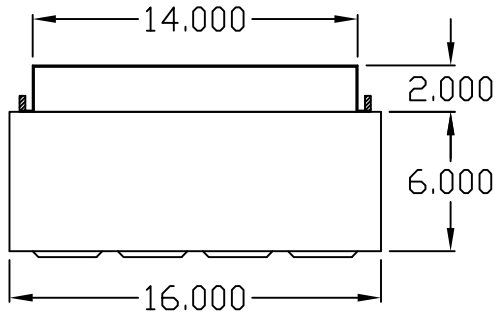

IQ3600HEV
SIDE VIEW

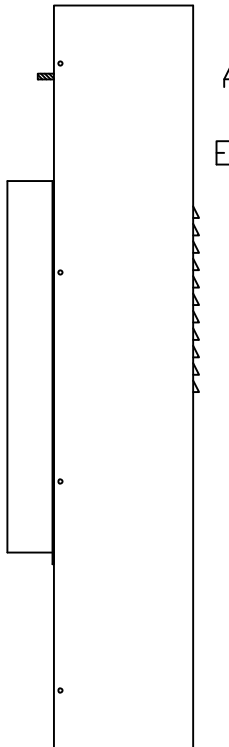

IQ3600HEV
FRONT VIEW

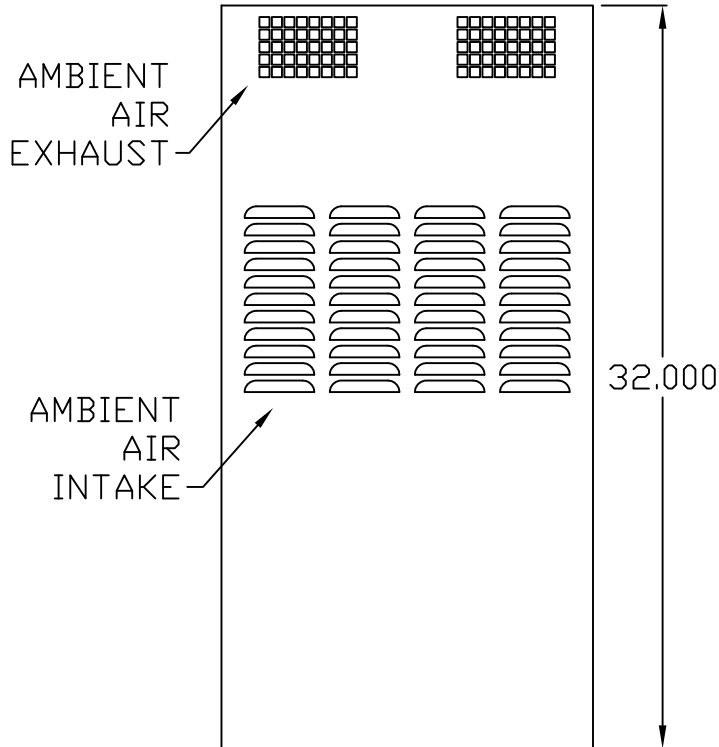

IQ3600HEV
SIDE VIEW

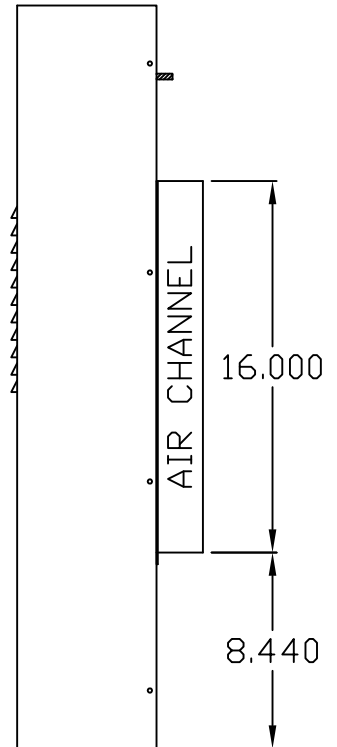

PROPRIETARY DRAWING
 THIS DRAWING IS THE PROPERTY OF ICE
 QUBE, INC. AND IS NOT TO BE DUPLICATED
 OR ALTERED WITHOUT AUTHORIZATION OF
 ICE QUBE, INC.

DRAWN GFD SCALE NONE
 DATE 9-27-04
 SHEET 2 OF 2

Ice Qube INDUSTRIAL COOLING EQUIPMENT
 141 WILSON AVENUE
 GREENSBURG, PA 15601
 724-837-2204 * 1-888-867-8234
 FAX 724-837-3386

IQ3600HEV
 IQ280510 1

IQ3600HEV
REAR VIEW

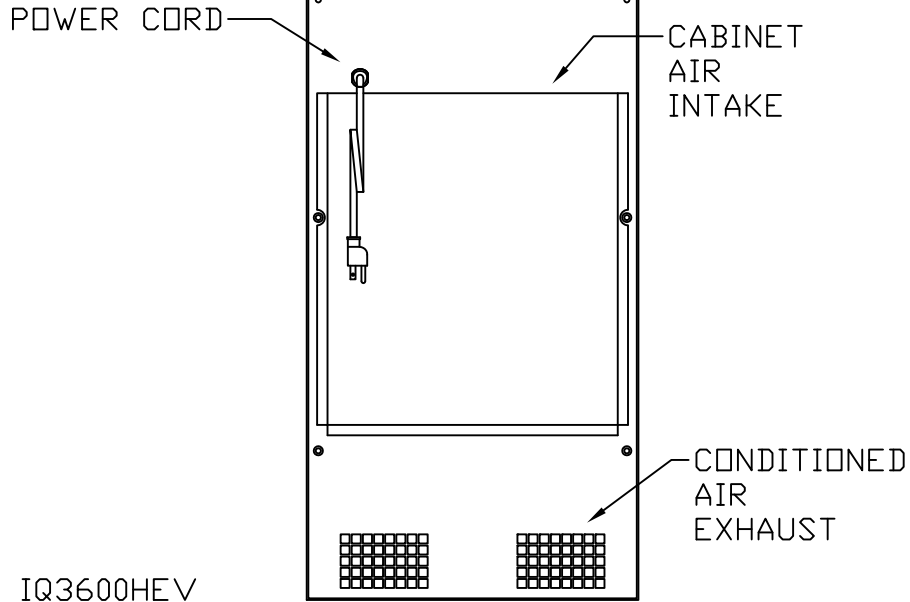

IQ3600HEV
CUTOUT DRAWING

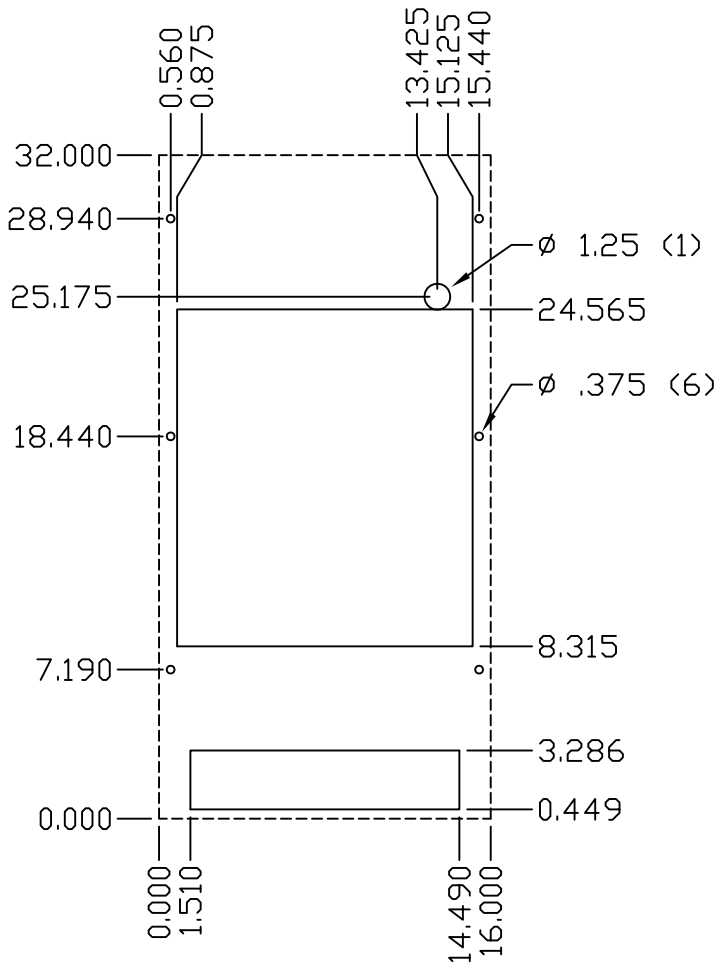

IQ3600HEV
GASKET DRAWING

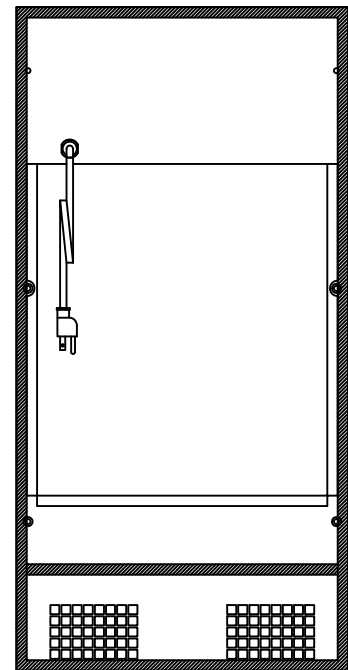

IMPORTANT
GASKET MUST BE
APPLIED AS SHOWN
FOR PROPER OPERATION
AND TO MAINTAIN
NEMA INTEGRITY

1	UPDATED VIEW	12-12-05	GFD
0	INITIAL RELEASE	9-27-04	GFD
REV	DESCRIPTION	DATE	CHECKED
	REVISIONS		

PROPRIETARY DRAWING
THIS DRAWING IS THE PROPERTY OF ICE
QUBE, INC. AND IS NOT TO BE DUPLICATED
OR ALTERED WITHOUT AUTHORIZATION OF
ICE QUBE, INC.

DRAWN GFD SCALE NONE
DATE 9-27-04
SHEET 1 OF 2

	INDUSTRIAL COOLING EQUIPMENT 141 WILSON AVENUE GREENSBURG, PA 15601 724-837-2204 * 1-888-867-8234 FAX 724-837-3386	
	IQ3600HEV	
	IQ280510	1