

IQ1200VS, IQ1500VS AND IQ1800VS SPEC DRAWINGS REV 1 480-400VAC

IQ1200VS

COOLING CAPACITY: 1200 BTUH @ 131°F
 MAXIMUM AMPS: 0.9/1.0 @480V 60/50HZ
 MAXIMUM AMPS: 1.0/1.2 @400V 60/50HZ
 MAXIMUM OPERATING TEMP.: 131°F
 DIMENSIONS: 26.28"H X 11.51"W X 6.26"D
 WEIGHT: 56 LBS

IQ1500VS

COOLING CAPACITY: 1500 BTUH @ 131°F
 MAXIMUM AMPS: 0.9/1.0 @480V 60/50HZ
 MAXIMUM AMPS: 1.1/1.2 @400V 60/50HZ
 MAXIMUM OPERATING TEMP.: 131°F
 DIMENSIONS: 26.28"H X 11.51"W X 6.26"D
 WEIGHT: 56 LBS

IQ1800VS

COOLING CAPACITY: 1800 BTUH @ 131°F
 MAXIMUM AMPS: 1.0/1.1 @480V 60/50HZ
 MAXIMUM AMPS: 1.2/1.3 @400V 60/50HZ
 MAXIMUM OPERATING TEMP.: 131°F
 DIMENSIONS: 26.28"H X 11.51"W X 6.26"D
 WEIGHT: 56 LBS

IQ1200VS
 IQ1500VS
 IQ1800VS
 TOP VIEW

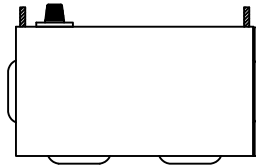

IQ1200VS
 IQ1500VS
 IQ1800VS
 LEFT SIDE

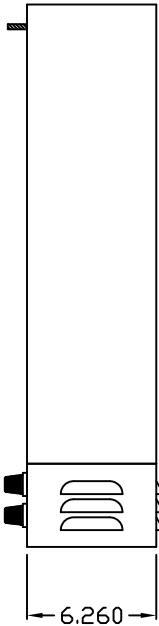

IQ1200VS
 IQ1500VS
 IQ1800VS
 FRONT VIEW

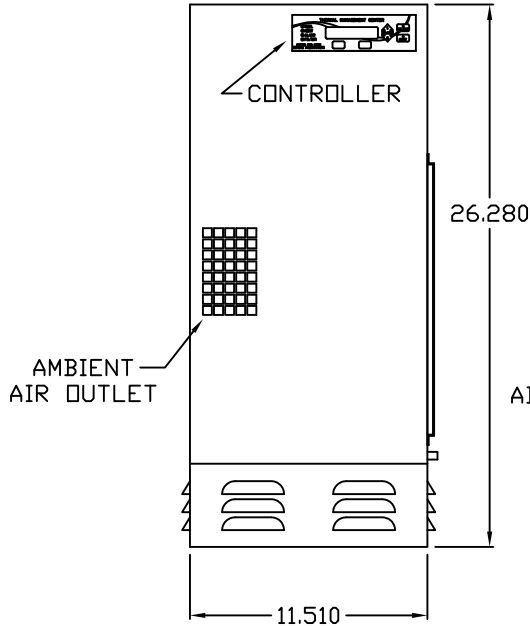

IQ1200VS
 IQ1500VS
 IQ1800VS
 RIGHT SIDE

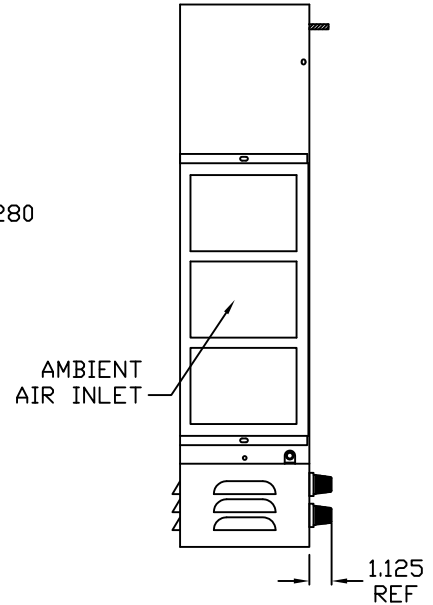

PROPRIETARY DRAWING
 THIS DRAWING IS THE PROPERTY OF ICE
 CUBE, INC. AND IS NOT TO BE REPLICATED
 OR ALTERED WITHOUT AUTHORIZATION OF
 ICE CUBE, INC.

DRAWN: JMH
 DATE: 2-26-10
 SCALE: NONE
 SHEET 2 OF 2

	INDUSTRIAL COOLING EQUIPMENT 141 WILSON AVENUE GREENSBURG, PA 15601 724-837-8204 # 1-888-867-8234 FAX 724-837-5086	
	IQ12-15-1800VS 480-400VAC	
IQ300223	1	

IQ1200VS
 IQ1500VS
 IQ1800VS
 REAR VIEW

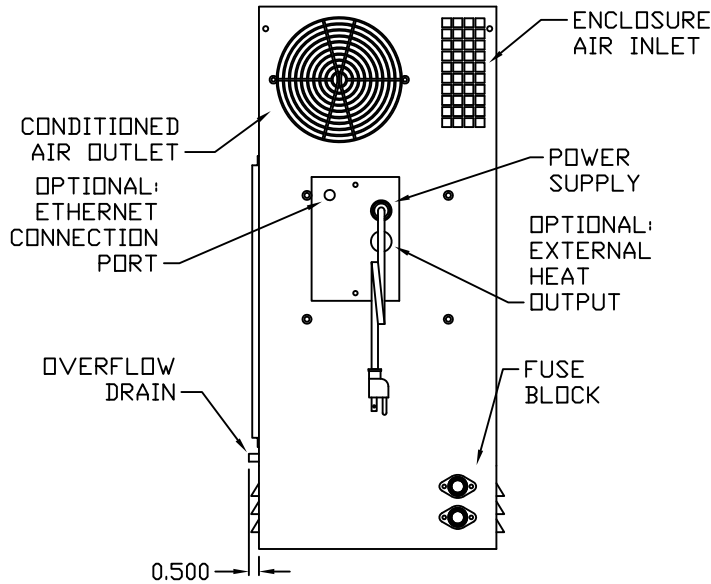

IQ1200VS
 IQ1500VS
 IQ1800VS
 CUT OUT DRAWING

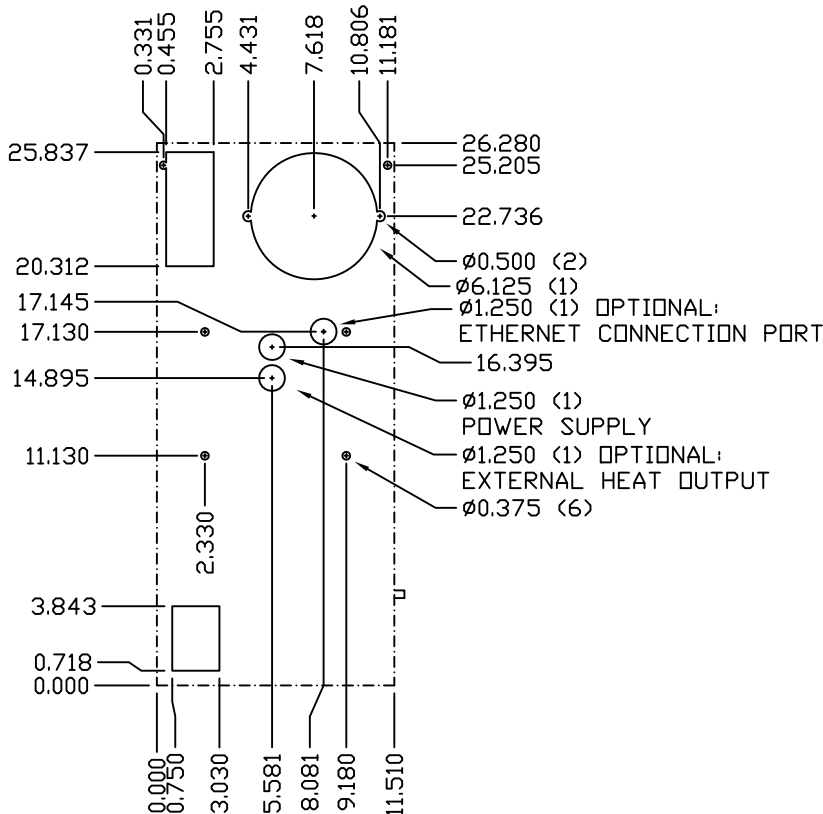

IQ1200VS
 IQ1500VS
 IQ1800VS
 GASKET DRAWING

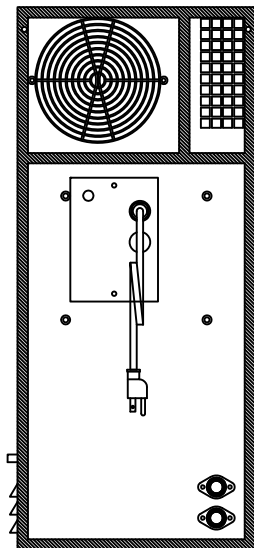

IMPORTANT
 GASKET MUST BE
 APPLIED AS SHOWN
 FOR PROPER OPERATION
 AND TO MAINTAIN
 NEMA INTEGRITY

1	ADDED FUSES & RECTANGLE FOR FUSE CUTOUT, ETHERNET CONNECTION PORT Ø1.250 WAS Ø0.750, 1200VS 480V 60HZ AMPS: 0.9 WAS 0.8	6-14-11	JJH
0	INITIAL RELEASE	2-26-10	JMH
REV	DESCRIPTION	DATE	CHECKED
	REVISIONS		

PROPRIETARY DRAWING
 THIS DRAWING IS THE PROPERTY OF JCE
 QUINC, INC. AND IS NOT TO BE REPLICATED
 OR ALTERED WITHOUT AUTHORIZATION OF
 JCE QUINC, INC.

DRAWN: JJH
 DATE: 2-26-10
 SCALE: NONE
 SHEET 1 OF 2

Jce
Quinc
 INDUSTRIAL COOLING EQUIPMENT
 141 WILSON AVENUE
 GREENSBURG, PA 15601
 724-837-8204 # 1-888-867-8234
 FAX: 724-837-5086

IQ12-15-1800VS
 480-400VAC

IQ300226 | 1