

IQ5500VS SPEC DRAWINGS REV 2

COOLING CAPACITY: 5500 BTUH @131°F
 MAXIMUM AMPS: 10.4 @120V/60HZ
 MAXIMUM AMPS: 5.2/5.7 @230/220 60/50HZ
 MAXIMUM OPERATING TEMP.: 131°F
 DIMENSIONS: 30.09"H X 12.27"W X 10.39"D
 WEIGHT: 75 LBS

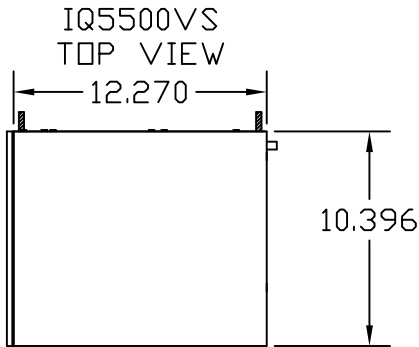

IQ5500VS
LEFT SIDE

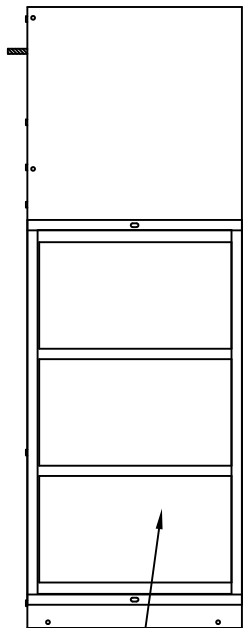

CONDENSER
AIR INLET

IQ5500VS
FRONT VIEW

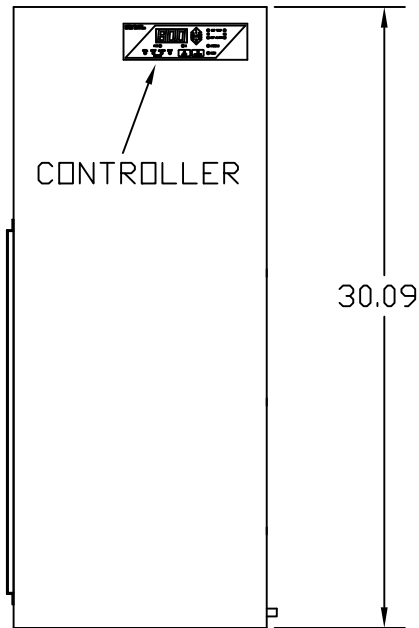

IQ5500VS
RIGHT SIDE

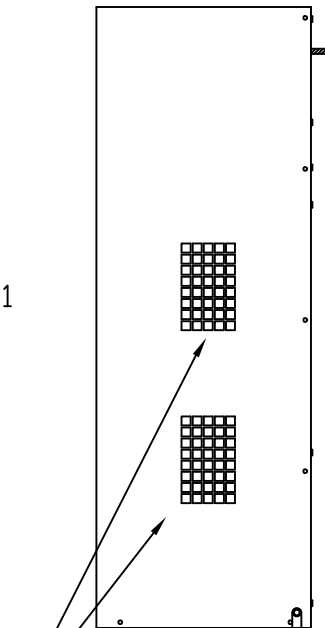

CONDENSER
AIR OUTLETS

PROPRIETARY DRAWING
 THIS DRAWING IS THE PROPERTY OF ICE
 QUBE, INC. AND IS NOT TO BE REPLICATED
 OR ALTERED WITHOUT AUTHORIZATION OF
 ICE QUBE, INC.

DRAWN J.J.H. SCALE NONE
 DATE 2-15-10
 SHEET 2 OF 2

Ice Qube INDUSTRIAL COOLING EQUIPMENT
 141 WILSON AVENUE
 GREENSBURG, PA 15601
 724-837-8204 • 1-888-867-8234
 FAX 724-837-9386

IQ5500VS

IQ300216

2

IQ5500VS
REAR VIEW

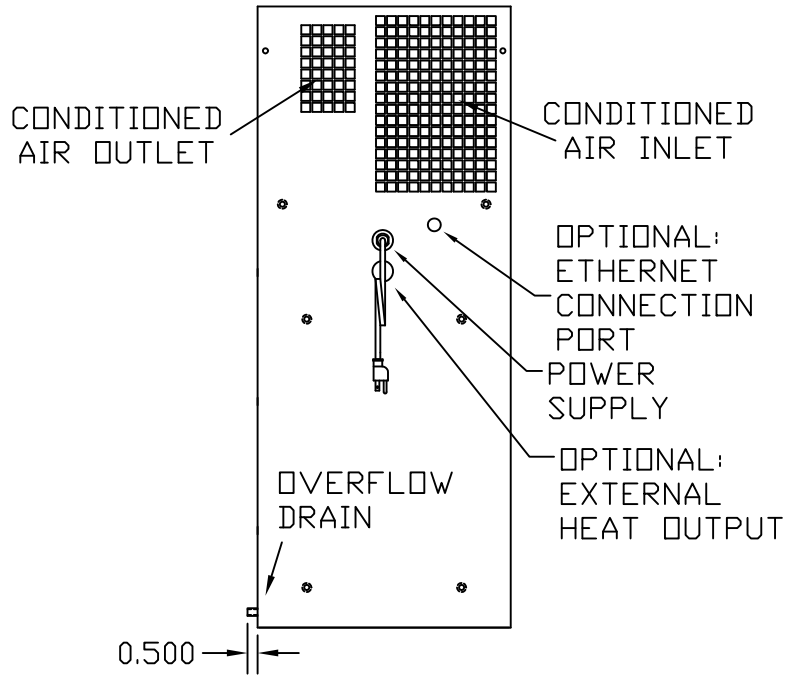

IQ5500VS
CUTOUT DRAWING

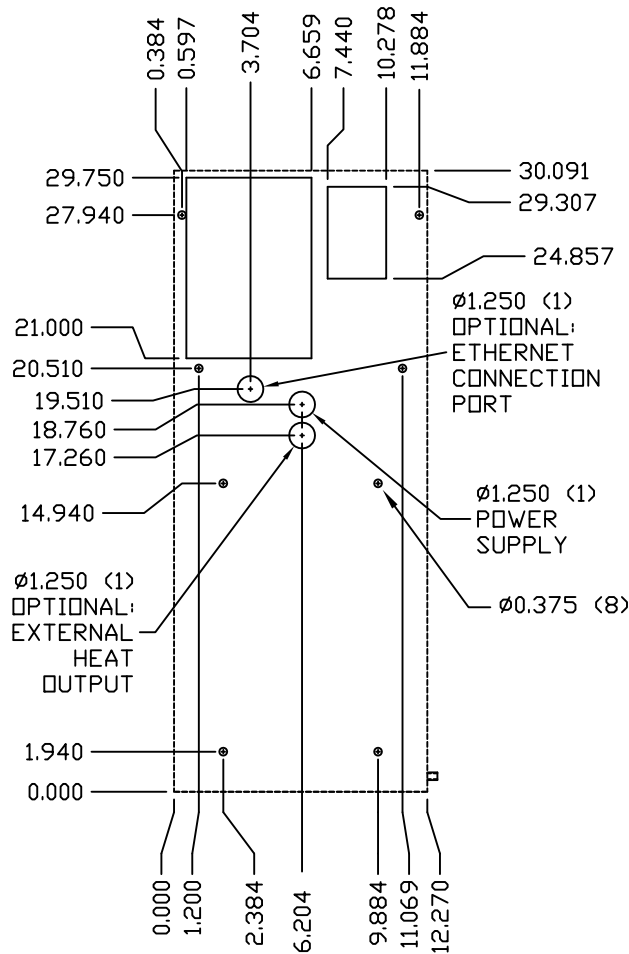

IQ5500VS
GASKET DRAWING

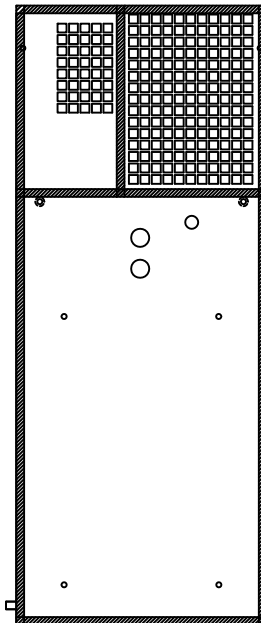

IMPORTANT
GASKET MUST BE
APPLIED AS SHOWN
FOR PROPER OPERATION
AND TO MAINTAIN
NEMA INTEGRITY.

REV	DESCRIPTION	DATE	CHECKED
2	ADDED ETHERNET CONNECTION PORT	7-21-11	JJH
1	UPDATE AMPS	10-17-10	JJH
0	INITIAL RELEASE	2-15-10	JJH
	REVISIONS		

PROPRIETARY DRAWING
THIS DRAWING IS THE PROPERTY OF JEE
CUBIC, INC. AND IS NOT TO BE REPLICATED
OR ALTERED WITHOUT AUTHORIZATION OF
JEE CUBIC, INC.

DRAWN JJH SCALE NONE
DATE 2-15-10
SHEET 1 OF 2

Jee
Cube

INDUSTRIAL COOLING EQUIPMENT
141 WILSON AVENUE
GREENSBURG, PA 15601
724-837-8204 ■ 1-888-867-8234
FAX 724-837-3286

IQ5500VS

IQ300216 2