

IQ900HE-CF SPEC DRAWING

COOLING CAPACITY: 7.4 WATTS/°F  
 MAXIMUM AMPS: 1.0/1.1 @ 120/110VAC 60/50HZ  
 MAXIMUM AMPS: .50/.60 @ 230/220VAC 60/50HZ  
 MAXIMUM AMPS: 1.12 @ 48VDC  
 DIMENSIONS: 28.75"H X 10.68"W X 3.96"D  
 WEIGHT: 34 LBS.

TOP VIEW

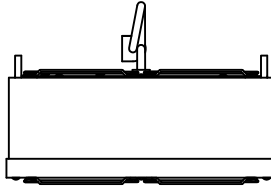

LEFT SIDE

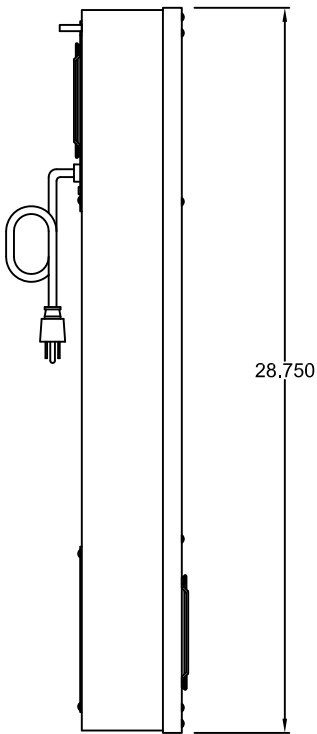

FRONT VIEW

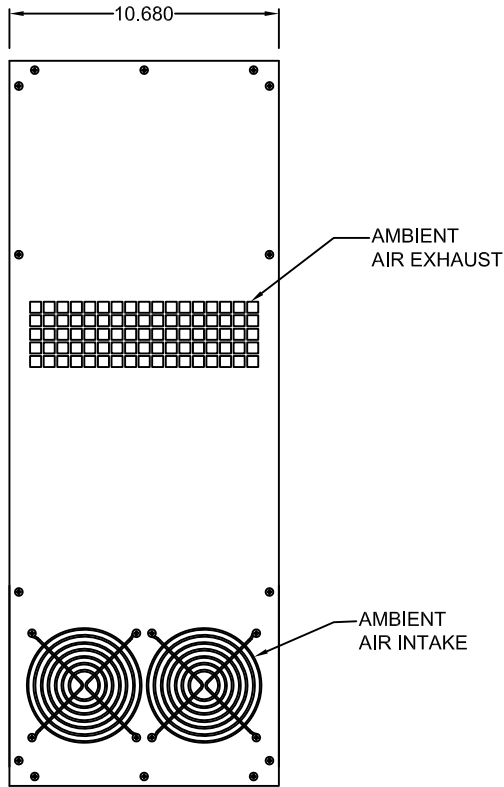

RIGHT SIDE

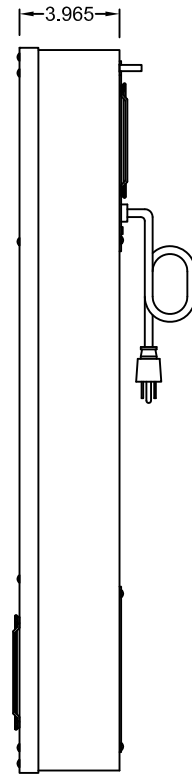

BOTTOM VIEW

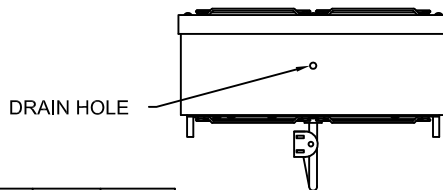

4	ADDED NOTE "FOR REF. ONLY"	8/20/19	TAS
3	REMOVED TEMP RANGE/CORRECTED CUTOUT & GASKET	7/2/15	EAD
2	ADDED TEMP RANGE AND CORRECTED AMP. DATA	6/5/14	AM
1	CHANGED DEPTH AND CUTOUT	8/18/11	JMH
0	INITIAL RELEASE	4/8/09	JMH
REV	DESCRIPTION	DATE	CHECKED
	REVISIONS		

PROPRIETARY DRAWING  
 THIS DRAWING IS THE PROPERTY OF ICE  
 QUBE, INC. AND IS NOT TO BE DUPLICATED  
 OR ALTERED WITHOUT AUTHORIZATION OF  
 ICE QUBE, INC.

DRAWN	SCALE
JMH	NONE
DATE	
4/8/09	
SHEET 1 OF 2	

 INDUSTRIAL COOLING EQUIPMENT 141 WILSON AVENUE GREENSBURG, PA 15601 724-937-2204 • 1-888-967-8234 FAX 724-937-3386
<h2>IQ900HE-CF</h2>
<h1>IQ290407</h1>
<h1>4</h1>

REAR VIEW

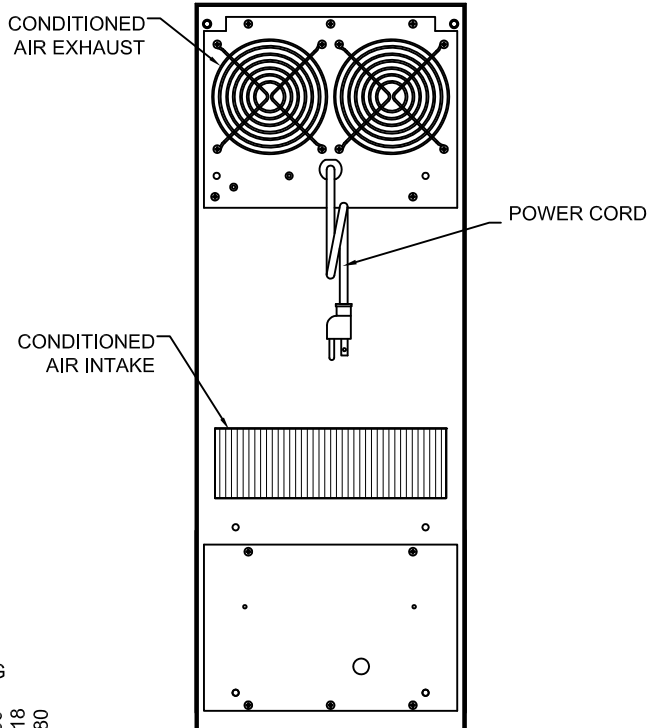

CUT OUT DRAWING

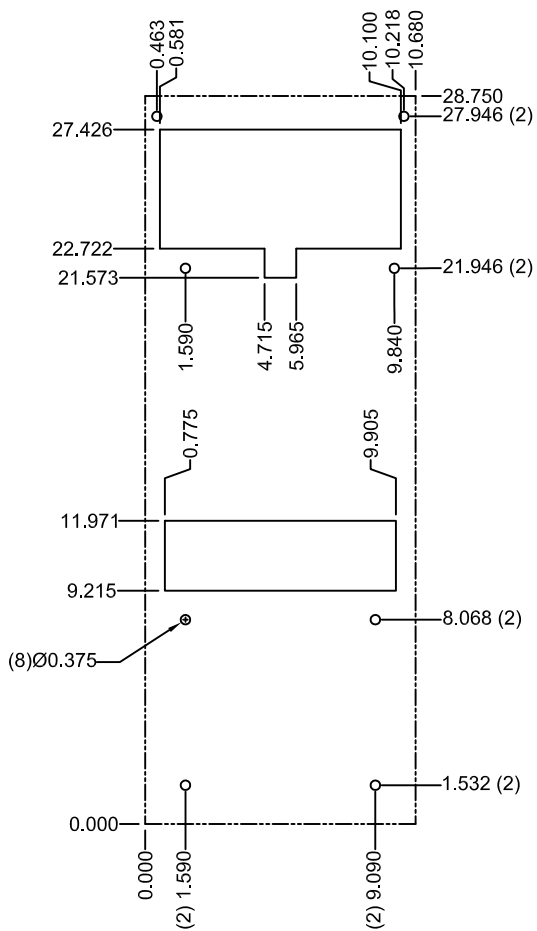

\*FOR REFERENCE ONLY\*  
 VARIES WITH OPTION  
 CONTACT ICE QUBE  
 FOR CORRECT CUT-OUT  
 DRAWING

GASKET DRAWING

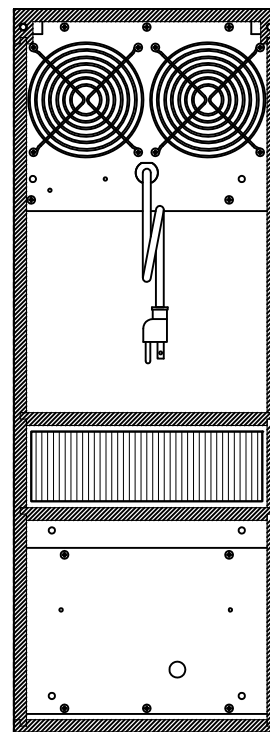

\*IMPORTANT\*  
 GASKET MUST BE  
 APPLIED AS SHOWN  
 FOR PROPER OPERATION  
 AND TO MAINTAIN  
 NEMA INTEGRITY.

PROPRIETARY DRAWING  
 THIS DRAWING IS THE PROPERTY OF ICE  
 QUBE, INC. AND IS NOT TO BE DUPLICATED  
 OR ALTERED WITHOUT AUTHORIZATION OF  
 ICE QUBE, INC.

DRAWN: JMH SCALE: NONE  
 DATE: 4/8/09  
 SHEET 2 OF 2

Ice Qube INDUSTRIAL COOLING EQUIPMENT  
 141 WILSON AVENUE  
 GREENSBURG, PA. 15601  
 724-837-3204 \* 1-888-867-8234  
 FAX: 724-837-3386

IQ900HE-CF

IQ290407