

IQ17000EVZ2 ZONE 2 ATEX IECEx CERTIFIED

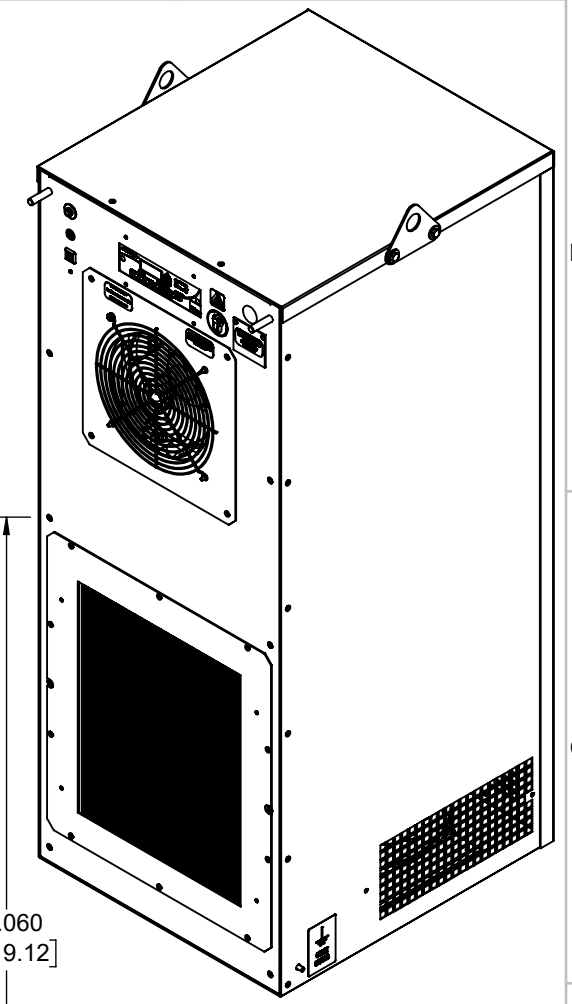

STANDARD
CONTROLLER
LOCATION

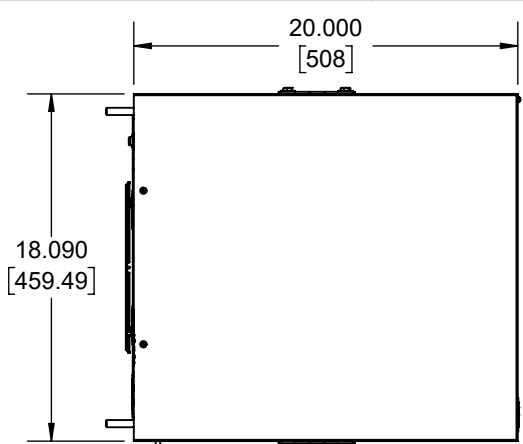
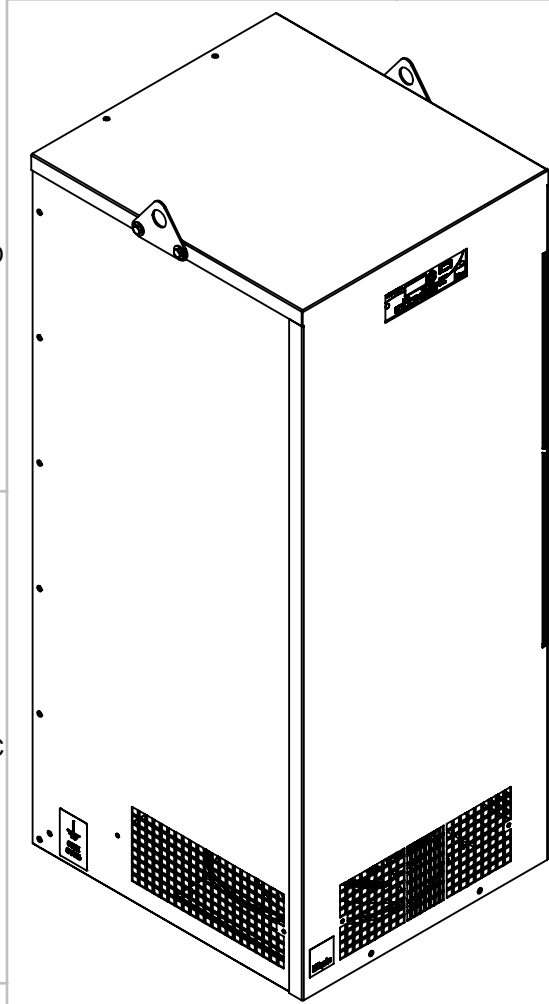
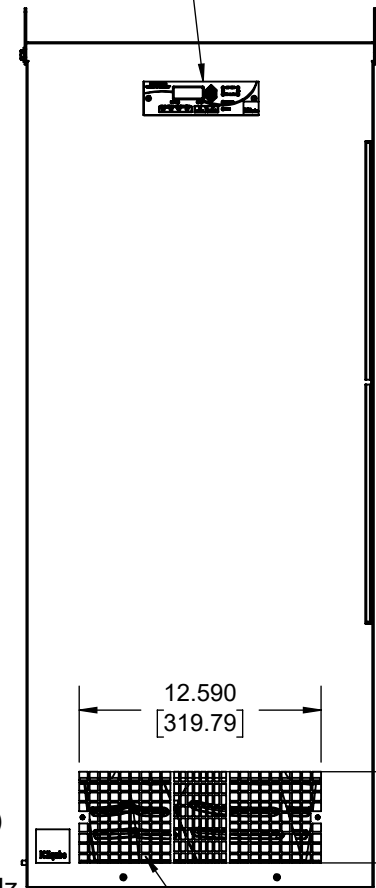

AMBIENT INTAKE FILTER

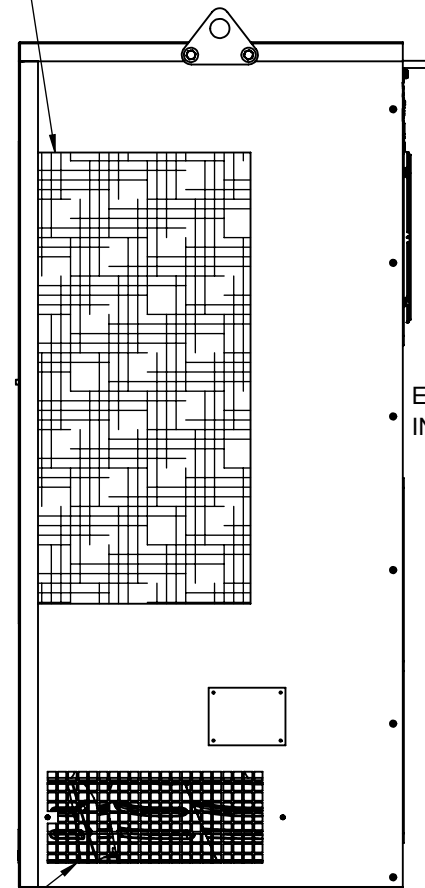

(2) 3/8-16 x 1.5LG HEX HEAD CAP SCREW

OPTIONAL
CONTROLLER
LOCATION

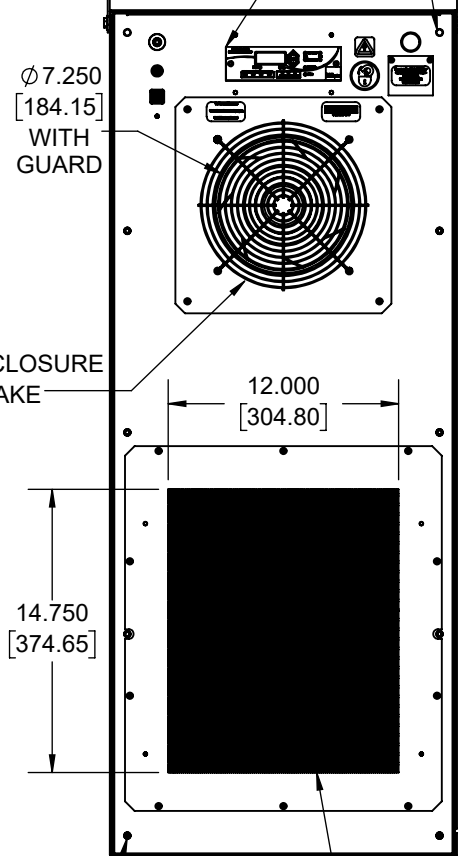

Ø7.250
[184.15]
WITH
GUARD

ENCLOSURE
INTAKE

12.000
[304.80]

14.750
[374.65]

ENCLOSURE
EXHAUST

(8) PEM, NUT, #1/4 - 20, .054"

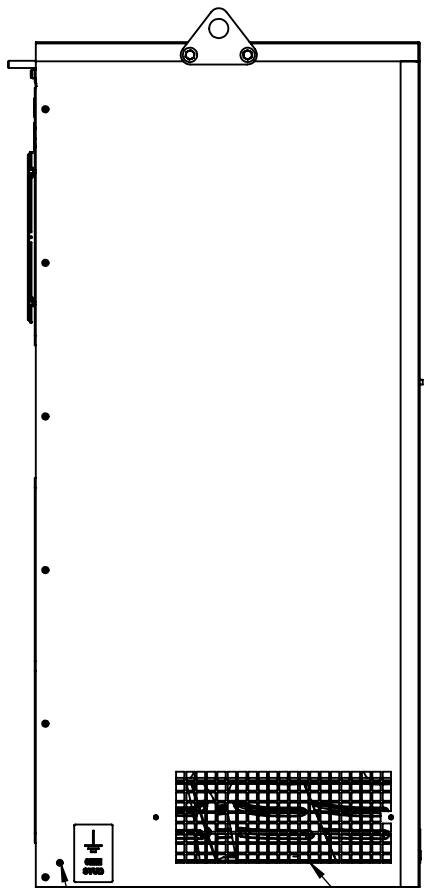

EXTERNAL GROUND
Ø6MM, 12MM LG STUD
WITH RING TERMINAL

AMBIENT EXHAUST

44.060
[1119.12]

IQ17000EVZ2
 CE 0539 II 3 G Ex nA nC IIC Txx Gc
 NOMINAL COOLING CAPACITY:
 17509 BTUH (5131W) @ 140-140°F (60°C-60°C)
 15144 BTUH (4437W) @ 95-95°F (35°C-35°C)
 MAXIMUM AMPS: 13.76 (3027W) @ 220V/50Hz
 MAXIMUM AMPS: 13.21 (3038W) @ 230V/60Hz
 MAXIMUM AMPS: 12.65 (3035W) @ 240V/50Hz
 MAXIMUM AMPS: 12.80 (3072W) @ 240V/60Hz
 MAXIMUM AMPS: 6.81 (2724W) @ 400V/50Hz
 MAXIMUM AMPS: 6.92 (2768W) @ 400V/60Hz
 MAXIMUM AMPS: 7.13 (3135W) @ 440V/50Hz
 MAXIMUM AMPS: 7.15 (3144W) @ 440V/60Hz
 MAXIMUM AMPS: 6.74 (3235W) @ 480V/50Hz
 MAXIMUM AMPS: 6.43 (3086W) @ 480V/60Hz
 MAINTAINS IP66 BETWEEN EQUIPMENT AND ENCLOSURE
 OPERATING TEMPERATURE: -40°C - +60°C
 T CODE: W/O CRANKCASE- T5
 T CODE: W/ CRANKCASE- T4
 DIMENSIONS: 44.060" (1119MM) H x 18.060" (459MM) W x 20.000" (508MM) D
 WEIGHT: 222 LBS (101KG) @ 220/230/240V
 WEIGHT: 274 LBS (125KG) @ 400/440/480V
 REFRIGERANT CHARGE-R407C: 2LB 12OZ (1247G)

12.590
[319.79]

4.742
[120.45]

AMBIENT EXHAUST

DRAIN TUBE .375" [9.53] O.D.

**RELATED DRAWING; DO NOT CHANGE WITHOUT
AUTHORIZED PERSON APPROVAL**

REV	DESCRIPTION	CHG	DATE	APP	DATE	CN #
B	ADDED CFM, dBA, 240V AND 440V 50/60HZ, AND CLEARANCE INFO	RCC	4/26/2018	JGG	4/26/2018	1347
A	PRODUCTION RELEASE	ART	12/4/2017	JGG	12/4/2017	1331

ITEM NUMBER N/A	USED ON IQ17000EVZ2
MATERIAL N/A	
EST WT: lbs	
DRAWN BY ART	DATE 12/4/2017
	SCALE 1:10

UNLESS OTHERWISE SPECIFIED TOLERANCES	
.X	±.060
.XX	±.030
.XXX	±.015
FRACTIONAL	±1/16
ANGULAR	±1/2°
SURFACE FINISH 63	
DO NOT SCALE DRAWING DIMENSIONS ARE INCHES	

ICE QUBE, INC.

THIS IS A PROPRIETARY DOCUMENT. DO NOT REPRODUCE OR DISCLOSE WITHOUT THE EXPRESS WRITTEN PERMISSION OF ICE QUBE, INC.

DESCRIPTION
**IQ17000EVZ2 ZONE 2 ATEX IECEx
SPEC DRAWING**

DRAWING NUMBER
IQ351565

REV
B

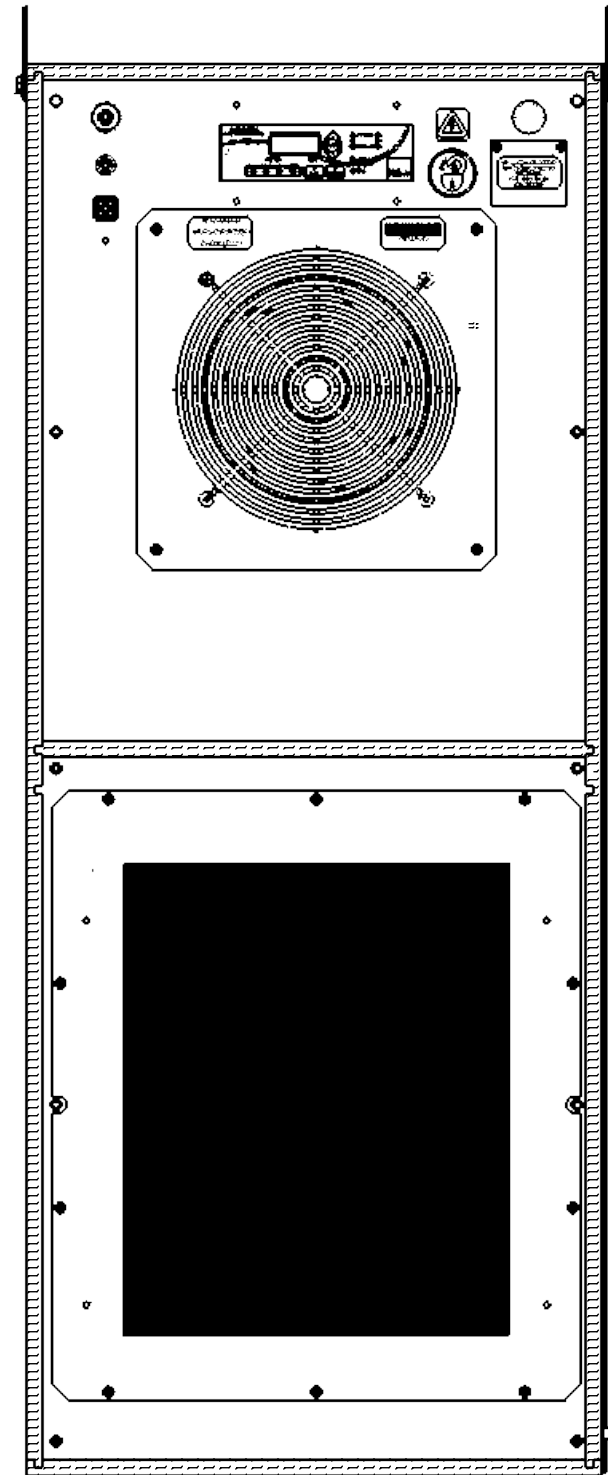
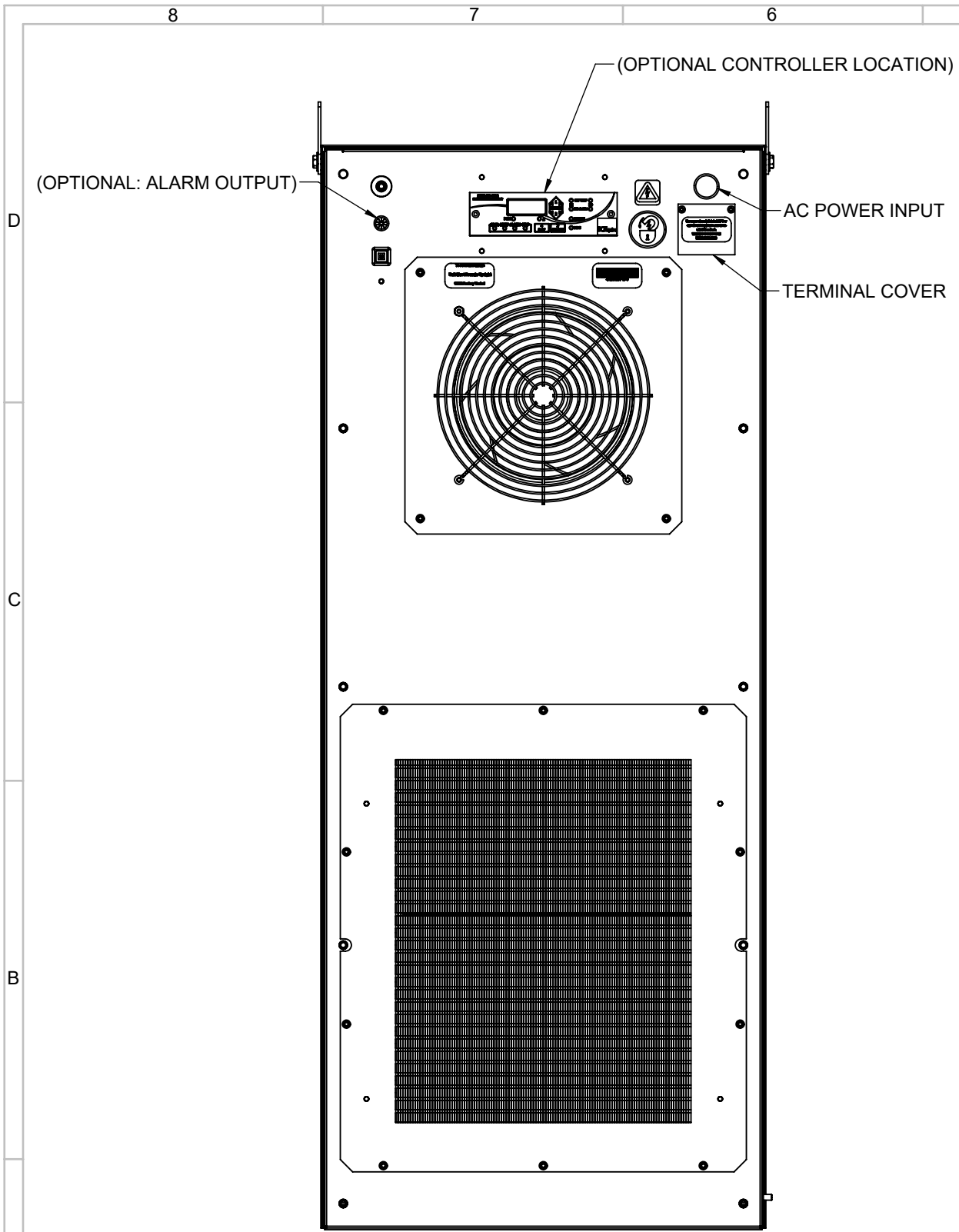

IMPORTANT
GASKET MUST BE APPLIED AS SHOWN FOR PROPER OPERATION AND TO MAINTAIN ENCLOSURE INTEGRITY

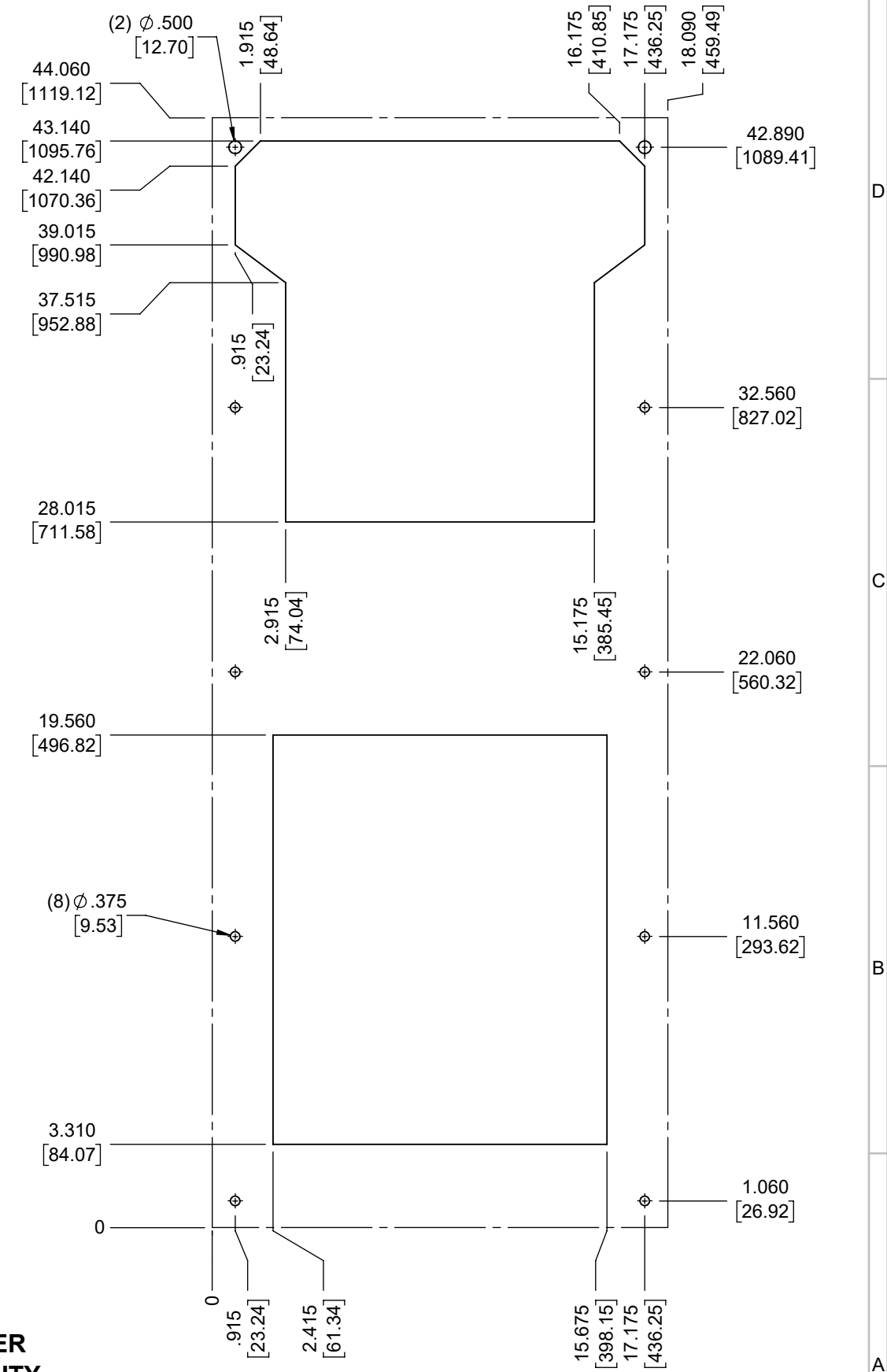

EVAP. OUTLET \approx 800 CFM
 COND. OUTLET \approx 1100 CFM
 SOUND LEVEL @5FT FROM UNIT @ A HT. OF 3FT = 65 dBA
 SOUND LEVEL @2FT FROM UNIT @ A HT. OF 5FT = 70 dBA
 CONDENSER INLET MIN. CLEARANCE 3.76"

ITEM NUMBER N/A	USED ON IQ17000EVZ2
MATERIAL N/A	
EST WT: lbs	
DRAWN BY ART	DATE 12/4/2017
	SCALE 1:6

UNLESS OTHERWISE SPECIFIED TOLERANCES	
X	\pm .060
.XX	\pm .030
.XXX	\pm .015
FRACTIONAL	\pm 1/4
ANGULAR	\pm 1/2°
SURFACE FINISH $\sqrt{63}$	
DO NOT SCALE DRAWING DIMENSIONS ARE INCHES	

ICE QUBE, INC.
THIS IS A PROPRIETARY DOCUMENT. DO NOT REPRODUCE OR DISCLOSE WITHOUT THE EXPRESS WRITTEN PERMISSION OF ICE QUBE, INC.

DESCRIPTION
IQ17000EVZ2 ZONE 2 ATEX ICEEX
SPEC DRAWING

DRAWING NUMBER
IQ351565

REV
B